

Profile cylinders conforms to
ISO 15552
Non-magnetic and magnetic piston
Double acting
Ø 32 to 125 mm

High performance, stability and reliability

M/50 switches can be mounted flush with the profile

Cylinders and mountings conform to ISO 15552 (ISO 6431, VDMA 24562 and NFE 49-003-1)

Polyurethane seals ensure efficient low friction operation and long life



Technical data

Medium:

Compressed air, filtered, lubricated or non-lubricated

Standard:

ISO 15552

Operation:

PRA/182000: double acting, adjustable cushioning

PRA/182000/M: double acting, magnetic piston, adjustable cushioning

Operating pressure:

1 to 16 bar

Operating temperature:

-20 to +80°C max.

(consult our Technical Service

for use below +2°C)

High temperature version: 150°C max.

Cylinder diameters:

32, 40, 50, 63, 80, 100, 125 mm

Strokes:

Standard: see page 3

Non-standard strokes available (10 to 3000 mm)

Materials:

Profile barrel: anodised aluminium

End covers: pressure diecast aluminium

Piston rod: stainless steel (Martensitic)

Piston rod seals: polyurethane Piston seals: polyurethane

O-rings: nitrile rubber

Ordering examples

See page 3

Mountings and switches

See page 4 and 5

Alternative variants

Single acting cylinders see page N/en 1.4.121

Cylinder with locking unit

See data sheet N/en 1.5.125.09 and 10

Guide blocks see page N/en 1.10.021

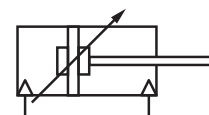

Non-magnetic piston

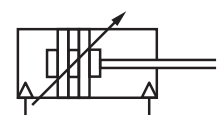

Magnetic piston

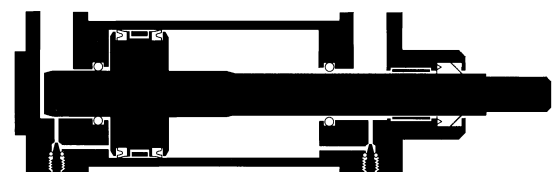

Cylinder variants

Symbol	Model Non-magnetic piston				Symbol	Model magnetic piston				Description	Dimensions	Page	
	H	T	C	S		H	T	C	S				
	•	•	•	•	PRA/182000		•	•	•	•	PRA/182000/M	Standard cylinder	6
			•	•	PRA/182000/W1				•	•	PRA/182000/W2	Cylinder with special wiper/seal (suitable for appl. with cement, plaster (stucco), arizona sand,hoar-frost or ice)	6
			•	•	PRA/182000/X1				•	•	PRA/182000/X2	Low friction cylinders, operating pressure: 1 to 10 bar Medium: Compressed air, filtered and non-lubricated recommended	6
				•	PRA/182000/IL						PRA/182000/MIL	Cylinder barrel turned at 90° for use with guide blocks QA/8000/51 and QA/8000/61	
	•	•	•	•	PRA/182000/IU		•	•	•	•	PRA/182000/MU	Cylinder with extended piston rod	6
			•	•	PRA/182000/W5				•	•	PRA/182000/W6	Cylinder with extended piston rod and special wiper/seal (suitable for applications with cement, plaster (stucco), arizona sand, hoar-frost or ice)	6
			•	•	PRA/182000/G				•	•	PRA/182000/MG	Cylinder with piston rod bellows	8
			•	•	PRA/182000/W				•	•	PRA/182000/MW	Cylinder without cushioning	6
			•	•	PRA/182000/X3				•	•	PRA/182000/X4	Low friction cylinders without cushioning, operating pressure: 1 to 10 bar Medium: Compressed air, filtered and non-lubricated recommended	6
	•	•	•	•	PRA/182000/J		•	•	•	•	PRA/182000/JM	Cylinder with double ended piston rod	7
			•	•	PRA/182000/W3				•	•	PRA/182000/W4	Cylinder with double ended piston rod and special wiper/seal (suitable for applications with cement, plaster (stucco), arizona sand, hoar-frost or ice)	7
	•				PRA/182000/IT		•				PRA/182000/MT	Four position cylinders	7
					PRA/182000/N1						PRA/182000/N2	Cylinder with non-rotating piston rod, Ø 32 to 100 mm	7
			•	•	PRA/182000/L2				•	•	PRA/182000/L4	Cylinder with locking unit (passive) spring force on removal of the signal to the unit. Operating pressure for locking unit: 4 to 10 bar	8

For the cylinder models style H*1), T, C and S see options selector
*1) Cylinder style H: Ø 32 ... 100 mm

Warning

These products are intended for use in industrial compressed air systems only. Do not use these products where pressures and temperatures can exceed those listed under 'Technical Data'.

Before using these products with fluids other than those specified, for non-industrial applications, life-support systems, or other applications not within published specifications, consult NORGREN.

Through misuse, age, or malfunction, components used in fluid power systems can fail in various modes.

The system designer is warned to consider the failure modes of all component parts used in fluid power systems and to provide adequate safeguards to prevent personal injury or damage to equipment in the event of such failure.

System designers must provide a warning to end users in the system instructional manual if protection against a failure mode cannot be adequately provided.

System designers and end users are cautioned to review specific warnings found in instruction sheets packed and shipped with these products.

Mountings

Style	A	AK	B, G	C	D	D2	F	FH	R
	10	18	1	2	5	7	15	9	3
Ø	Page 9	Page 9	Page 9	Page 9	Page 9	Page 9	Page 10	Page 10	Page 10
32	QM/8032/35	QM/8025/38	QA/8032/22	QA/8032/21	QA/8032/23	QA/8032/42	QM/8025/25	QA/8032/34	QA/8032/27
40	QM/8032/35	QM/8040/38	QA/8040/22	QA/8040/21	QA/8040/23	QA/8040/42	QM/8040/25	QA/8040/34	QA/8040/27
50	QM/8050/35	QM/8050/38	QA/8050/22	QA/8050/21	QA/8050/23	QA/8050/42	QM/8050/25	QA/8050/34	QA/8050/27
63	QM/8050/35	QM/8050/38	QA/8063/22	QA/8063/21	QA/8063/23	QA/8063/42	QM/8050/25	QA/8063/34	QA/8063/27
80	QM/8080/35	QM/8080/38	QA/8080/22	QA/8080/21	QA/8080/23	QA/8080/42	QM/8080/25	QA/8080/34	QA/8080/27
100	QM/8080/35	QM/8080/38	QA/8100/22	QA/8100/21	QA/8100/23	QA/8100/42	QM/8080/25	QA/8100/34	QA/8100/27
125	QM/8125/35	QM/8125/38	QM/8125/22	QM/8125/21	QM/8125/23	QA/8125/42	QM/8125/25	QA/8125/34	QM/8125/27
Style	S	SS	SW	UF	UH	UR	US	Groove key	Groove cover
	12	16	6	17	11	4	8	14	
Ø	Page 11	Page 11	Page 11	Page 10	Page 10	Page 10	Page 11	Page 14	Page 12
32	QA/8032/41	M/P19931	M/P19493	QM/8025/32	PQA/182032/40	QA/8032/33	M/P40310	M/P72816	M/K72725/1000
40	QA/8040/41	M/P19932	M/P19494	QM/8040/32	PQA/182040/40	QA/8040/33	M/P40311	M/P72816	M/K72725/1000
50	QA/8040/41	M/P19933	M/P19495	QM/8050/32	PQA/182050/40	QA/8050/33	M/P40312	M/P72816	M/K72725/1000
63	QA/8063/41	M/P19934	M/P19496	QM/8050/32	PQA/182063/40	QA/8063/33	M/P40313	M/P72816	M/K72725/1000
80	QA/8063/41	M/P19935	M/P19497	QM/8080/32	PQA/182080/40	QA/8080/33	M/P40314	M/P72816	M/K72725/1000
100	QA/8100/41	M/P19936	M/P19498	QM/8080/32	PQA/182100/40	QA/8100/33	M/P40315	M/P72816	M/K72725/1000
125	QA/8100/41	M/P19937	M/P19499	QM/8125/32	PQA/182125/40	QM/8125/33	M/P71355	M/P72816	M/K72725/1000
Valve mounting kit			Guide block						
	13	19							
Ø	Page 11	Data sheet 1.10.021							
32	-								
40	-								
50	QA/180050/22/54								
63	QA/180050/22/54								
80	QA/180080/22/54								
100	QA/180080/22/54								
125	QA/180080/22/54								

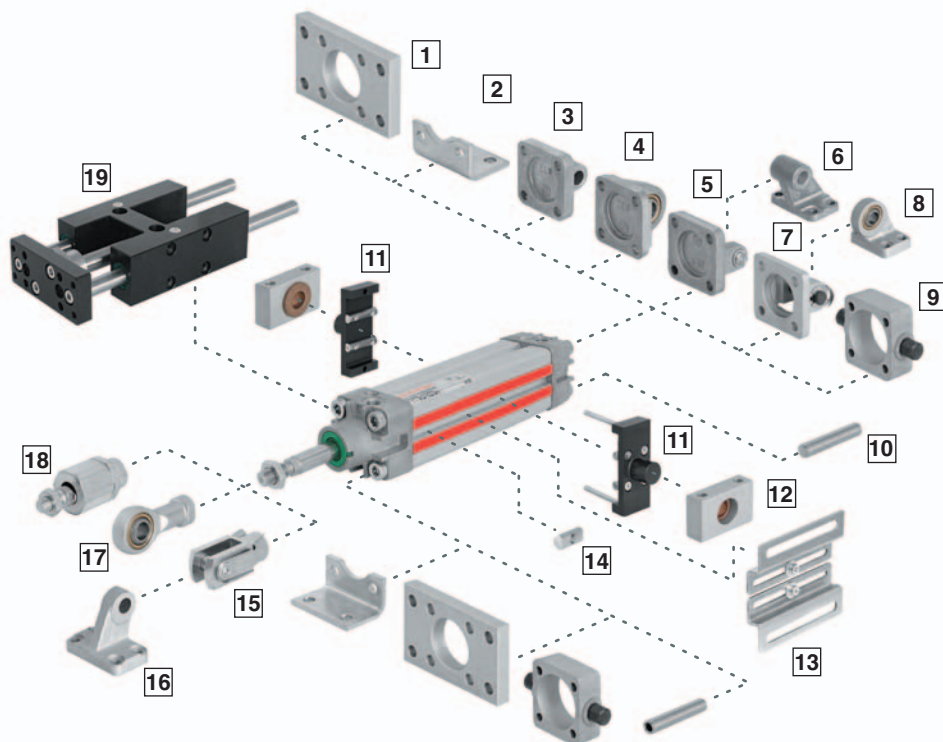

Switches

Type Reed	With cable		With connector (M8x1)		Current max.	Temperature °C	LED	Features	Cable/ Connector length	Cable type	Cable with Connector	Datasheet
	Solid state	Voltage V a.c.	V d.c.	V d.c.								
M/50/LSU/*V	–	10 to 240	10 to 170	180 mA	-20 to +80	•	–	–	2, 5, 10 m	PVC 2 x 0,25	–	N/en 4.3.005
M/50/LSU/5U	–	10 to 240	10 to 170	180 mA	-20 to +80	•	–	–	5 m	PUR 2 x 0,25	–	N/en 4.3.005
TM/50/RAU/2S	–	10 to 240	10 to 170	180 mA	-20 to +150	–	–	–	2 m	Silicone 2 x 0,25	–	N/en 4.3.005
M/50/RAC/5V	–	10 to 240	10 to 170	180 mA	-20 to +80	–	Changeover	–	5 m	PVC 3 x 0,25	–	N/en 4.3.005
M/50/LSU/CP	–	10 to 60	10 to 75	180 mA	-20 to +80	•	Plug M8x1	–	5 m	PVC 3 x 0,25	M/P73001/5	N/en 4.3.005
–	M/50/EAP/*V	–	10 to 30	150 mA	-20 to +80	•	PNP	–	2, 5, 10 m	PVC 3 x 0,25	–	N/en 4.3.007
–	M/50/EAP/CP	–	10 to 30	150 mA	-20 to +80	•	PNP, Plug M8x1	–	5 m	PVC 3 x 0,25	M/P73001/5	N/en 4.3.007
–	M/50/EAP/CC	–	10 to 30	150 mA	-20 to +80	•	PNP, Plug M12x1	–	5 m	PVC 3 x 0,25	M/P34614/5	N/en 4.3.007
–	M/50/EAN/*V	–	10 to 30	150 mA	-20 to +80	•	NPN	–	2, 5, 10 m	PVC 3 x 0,25	–	N/en 4.3.007
–	M/50/EAN/CP	–	10 to 30	150 mA	-20 to +80	•	NPN, Plug M8x1	–	5 m	PVC 3 x 0,25	M/P73001/5	N/en 4.3.007

* Please insert cable length
Further information (technical data, cable material, dimensions) see datasheet.

Theoretical forces, cushion, air consumption

Type	Cylinder Ø	Theoretical forces (N) at 6 bar outstroke	Theoretical forces (N) at 6 bar instroke	Cushion length (mm)	Initial cushion volume (cm ³)	Air consumption (l/cm stroke) at 6 bar outstroke	Air consumption (l/cm stroke) at 6 bar instroke
PRA/182032/.	32	482	414	19	12,3	0,056	0,048
PRA/182040/.	40	754	633	22	20,7	0,088	0,074
PRA/182050/.	50	1178	990	24	36	0,137	0,114
PRA/182063/.	63	1870	1680	24	64	0,218	0,195
PRA/182080/.	80	3016	2722	27	116	0,35	0,32
PRA/182100/.	100	4710	4416	34	242	0,55	0,51
PRA/182125/.	125	7363	6882	41	451	0,86	0,79

Basic dimensions

PRA/182000, PRA/182000/M – Standard cylinder

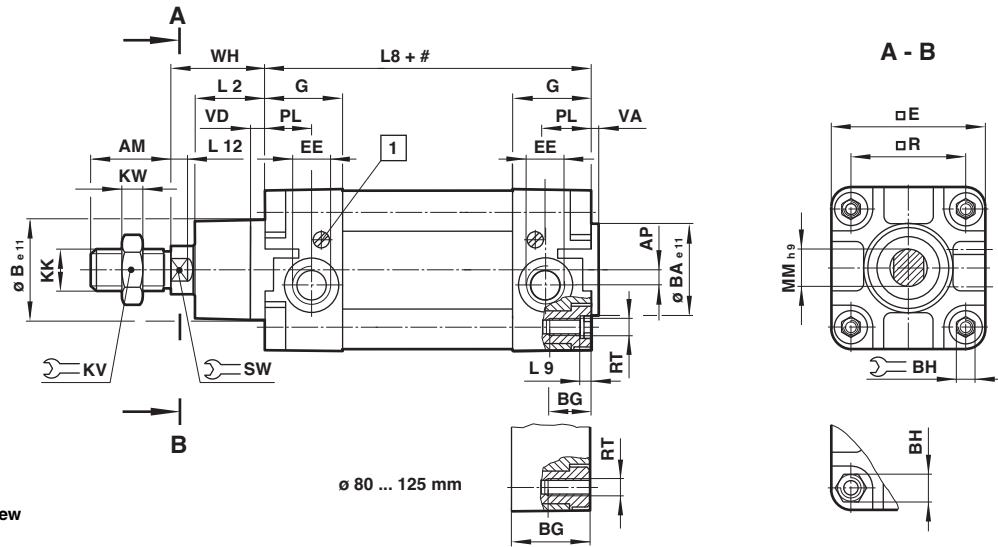

stroke
1 cushion screw

ø 80 ... 125 mm

Type	Ø	AM	AP	Ø Be 11	Ø BAe 11	BG	BH	E	EE	G	KK	KV	KW	L2
PRA/182032/.	32	22	3,5	30	30	16	6	47	G 1/8	27,5	M10x1,25	17	5	20
PRA/182040/.	40	24	4,5	35	35	16	6	53	G 1/4	32	M12x1,25	19	6	22
PRA/182050/.	50	32	6	40	40	16	8	65	G 1/4	31	M16x1,5	24	8	27
PRA/182063/.	63	32	10	45	45	16	8	75	G 3/8	33	M16x1,5	24	8	29
PRA/182080/.	80	40	8,5	45	45	17	19	95	G 3/8	33	M20x1,5	30	10	33
PRA/182100/.	100	40	9	55	55	17	19	115	G 1/2	37	M20x1,5	30	10	36
PRA/182125/.	125	54	10	60	60	20	24	140	G 1/2	46	M27x2	41	13,5	45
Type	Ø	L8	L9	L12	Ø MMh 9	PL	R	RT	SW	VA	VD	WH	at 0 mm	per 25 mm
PRA/182032/.	32	94	4	6	12	13	32,5	M 6	10	3	6	26	0,51 kg	0,06 kg
PRA/182040/.	40	105	4	6,5	16	15	38	M 6	13	3,5	6	30	0,80 kg	0,08 kg
PRA/182050/.	50	106	5	8	20	18,5	46,5	M 8	17	3,5	6	37	1,33 kg	0,12 kg
PRA/182063/.	63	121	5	8	20	19	56,5	M 8	17	4	6	37	1,80 kg	0,13 kg
PRA/182080/.	80	128	-	10	25	19	72	M 10	22	4	6	46	3,25 kg	0,20 kg
PRA/182100/.	100	138	-	10	25	18	89	M 10	22	4	6	51	4,81 kg	0,23 kg
PRA/182125/.	125	160	-	13	32	20	110	M 12	27	6	15,5	65	8,00 kg	0,33 kg

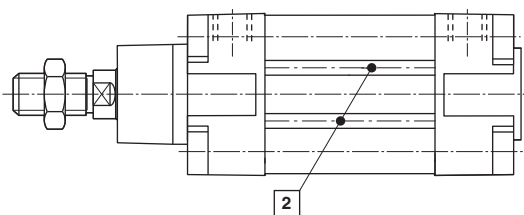

2 M/50 switches can be mounted flush with the profile

Alternative variants

PRA/182000/J, PRA/182000/JM – Cylinder with double ended piston rod

Type	Ø	ZM	L8
PRA/182032/J.	32	146	94
PRA/182040/J.	40	165	105
PRA/182050/J.	50	180	106
PRA/182063/J.	63	195	121
PRA/182080/J.	80	220	128
PRA/182100/J.	100	240	138
PRA/182125/J.	125	290	160

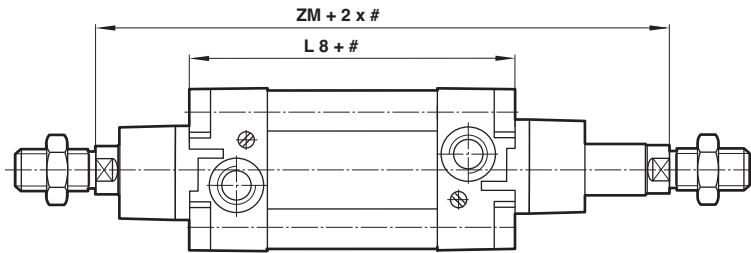

PRA/182000/N1, PRA/182000/N2 – Cylinder with non-rotating piston rod

Type	Ø		Max. torque (Nm)
PRA/182032/N.	32	10	0,5
PRA/182040/N.	40	13	1,0
PRA/182050/N.	50	16	1,5
PRA/182063/N.	63	16	1,5
PRA/182080/N.	80	16	2,5
PRA/182100/N.	100	21	2,5

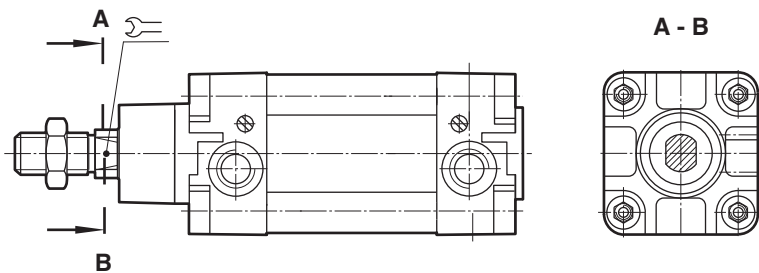

PRA/182000/IT, PRA/182000/MT – Four-position cylinder

Type	Ø	L 8	L 10	L 11
PRA/182032/T.	32	94	247	7
PRA/182040/T.	40	105	278	8
PRA/182050/T.	50	106	294	8
PRA/182063/T.	63	121	325	9
PRA/182080/T.	80	128	357	9
PRA/182100/T.	100	138	387	9
PRA/182125/T.	125	160	462	12

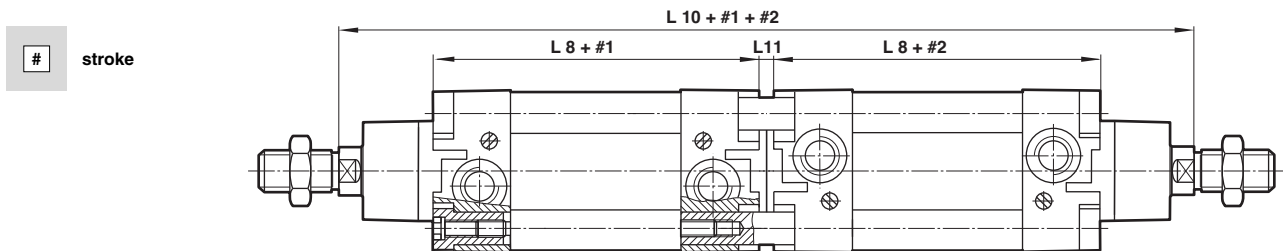

PRA/182000/G, PRA/182000/MG – Piston rod bellow

Type	Ø	Ø A	Max. stroke per bellow	Piston rod extension B for first bellow for further bellow	
PRA/182032/.G	32	40	60	30	25
PRA/182040/.G	40	63	145	50	32
PRA/182050/.G	50	63	145	40	32
PRA/182063/.G	63	63	145	40	32
PRA/182080/.G	80	80	250	50	45
PRA/182100/.G	100	80	250	50	45
PRA/182125/.G	125	80	250	50	45

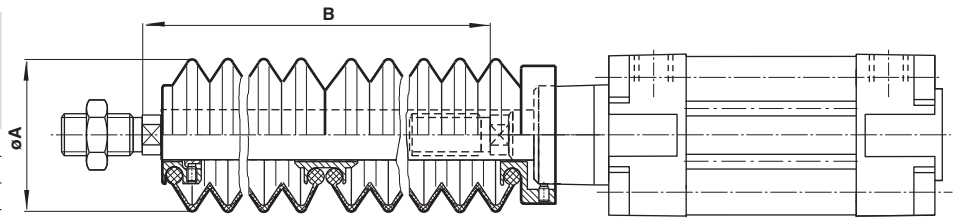

PRA/182000/L2, PRA/182000/L4 – Cylinder with locking unit (passive)

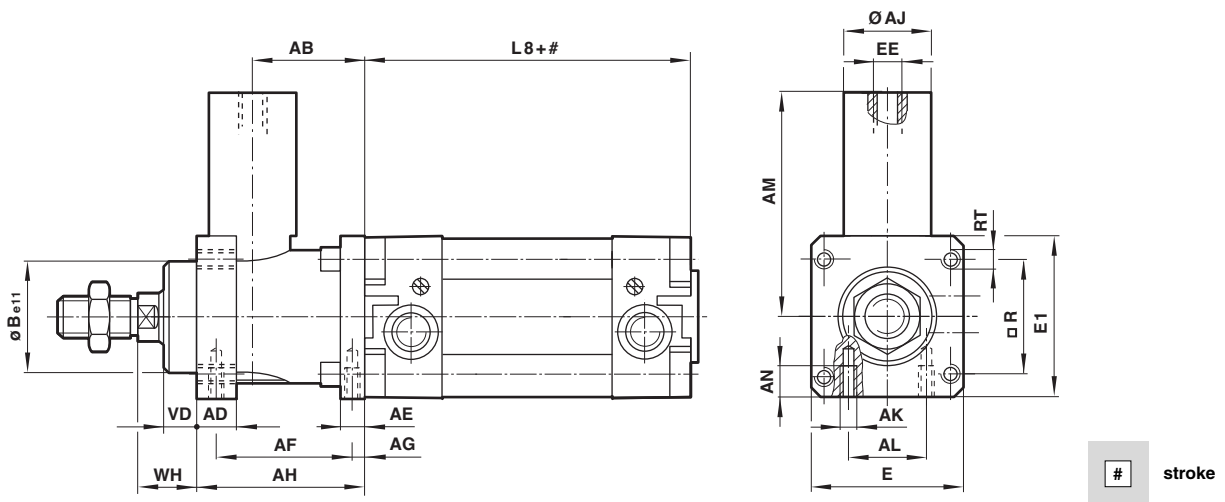

Type	Ø	AB	AD	AE	AF	AG	AH	Ø AJ	AK	AL	AM	AN
PRA/182032/L./.	32	32	12	8	40	4,2	48	25	M 5	16	59	8
PRA/182040/L./.	40	35,5	12	10	46	4,5	55	24	M 5	21	61,5	10
PRA/182050/L./.	50	49	16	15	54	11,5	70	30	M 6	24	75	12
PRA/182063/L./.	63	49	15	15	55	7,5	70	38	M 8	32	86	12
PRA/182080/L./.	80	62	16	16	70	10	90	53	M 8	44	119	16
PRA/182100/L./.	100	65	18	16	70	10	92	48	M 8	60	119	16
PRA/182125/L./.	125	85	27	25	95	11	122	65	M 10	75	140	20
Type	Ø	Ø B e11	E	E 1	EE	L 8	□ R	RT	VD	WH	Locking force	
PRA/182032/L./.	32	30	48	50	M 5	94	32,5	M 6	10	16	600 N	
PRA/182040/L./.	40	35	56	58	G 1/8	105	38	M 6	10	18	1000 N	
PRA/182050/L./.	50	40	68	70	G 1/8	106	46,5	M 8	12	22	1500 N	
PRA/182063/L./.	63	45	82	85	G 1/8	121	56,5	M 8	12	20	2200 N	
PRA/182080/L./.	80	45	100	105	G 1/8	128	72	M 10	20	33	5000 N	
PRA/182100/L./.	100	55	120	130	G 1/8	138	89	M 10	23	38	5000 N	
PRA/182125/L./.	125	60	140	150	G 1/8	160	110	M 12	32	65	7000 N	

Mountings

Front or rear stud mounting A

Conforms to ISO 15552, type MX1

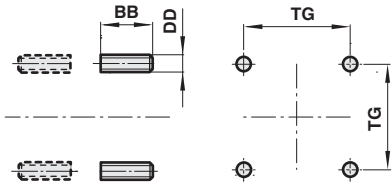

Style (A)	Ø	BB	DD	TG	kg
QM/8032/35	32/40	17	M6	32,5/38	0,02
QM/8050/35	50/63	23	M8	46,5/56,5	0,05
QM/8080/35	80/100	28	M10	72/89	0,08
QM/8125/35	125	34	M12	110	0,14

Piston rod swivel AK

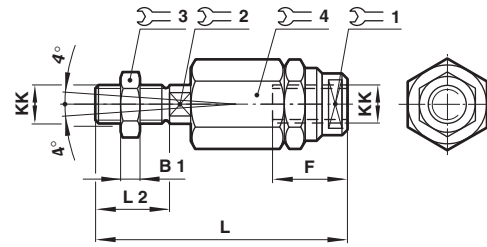

Style (AK)	Ø	KK	B1	F	L	L2	1	2	3	4	kg
QM/8025/38	32	M10x1,25	5	26	73	20	19	12	17	30	0,20
QM/8040/38	40	M12x1,25	6	26	77	24	19	12	19	30	0,20
QM/8050/38	50/63	M16x1,5	8	34	106	32	30	19	24	42	0,65
QM/8080/38	80/100	M20x1,5	10	42	122	40	30	19	30	42	0,72
QM/8125/38	125	M27x2	13,5	40	147	54	40	24	41	55	1,70

**Rear flange B
Front flange G**

Conforms to ISO 15552, type MF1 and MF2

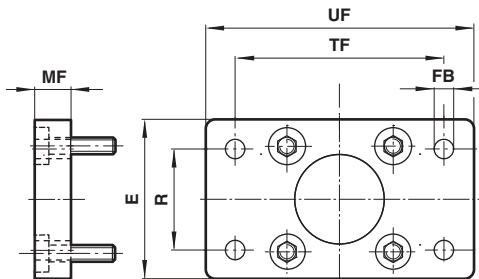

Style (B - G)	Ø	E	Ø FB	MF	R	TF	UF	kg
QA/8032/22	32	50	7	10	32	64	80	0,25
QA/8040/22	40	55	9	10	36	72	90	0,35
QA/8050/22	50	65	9	12	45	90	110	0,70
QA/8063/22	63	75	9	12	50	100	125	0,80
QA/8080/22	80	100	12	16	63	126	154	1,35
QA/8100/22	100	120	14	16	75	150	186	2,20
QM/8125/22	125	140	16	20	90	180	224	2,70

Foot mounting C

Conforms to ISO 15552, type MS1

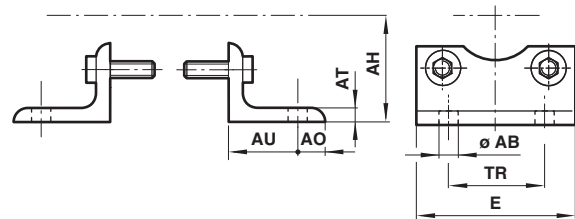

Style (C)	Ø	Ø AB	AH	A0	AT	AU	E	TR	kg
QA/8032/21	32	7	32	8	4	24	48	32	0,15
QA/8040/21	40	9	386	9	4	28	53	36	0,18
QA/8050/21	50	9	45	10	5	32	64	45	0,30
QA/8063/21	63	9	50	12	5	32	74	50	0,39
QA/8080/21	80	12	63	19	5	41	98	63	0,80
QA/8100/21	100	14	71	19	5	41	115	75	0,95
QM/8125/21	125	16	90	20	9	45	140	90	2,40

Rear clevis D

Conforms to ISO 15552, type MP2

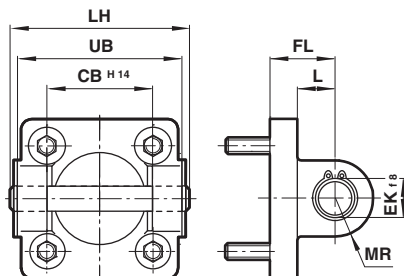

Style (D)	Ø	CB H14	Ø EK H9	FL	L	LH	MR	UB	kg
QA/8032/23	32	26	10	22	13	52	9	45	0,11
QA/8040/23	40	28	12	25	16	60	12	52	0,16
QA/8050/23	50	32	12	27	17	68	12	60	0,22
QA/8063/23	63	40	16	32	22	79	15	70	0,34
QA/8080/23	80	50	16	36	22	99	15	90	0,54
QA/8100/23	100	60	20	41	27	119	20	110	0,90
QM/8125/23	125	70	25	50	31	139	25	130	2,70

Rear clevis D2

Conforms ISO 15552, type AB6

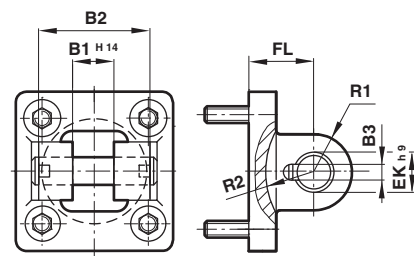

Style (D2)	Ø	B1 H14	B2	B3	Ø EK H9	FL	R1	R2	kg
QA/8032/42	32	14	34	3,3	10	22	11	17	0,20
QA/8040/42	40	16	40	4,3	12	25	12	20	0,23
QA/8050/42	50	21	45	4,3	16	27	14,5	22	0,36
QA/8063/42	63	21	51	4,3	16	32	18	25	0,55
QA/8080/42	80	25	65	4,3	20	36	22	30	0,90
QA/8100/42	100	25	75	4,3	20	41	22	32	1,45
QA/8125/42	125	37	97	6,3	30	50	30	42	2,70

Piston rod clevis F

Conforms to DIN ISO 8140

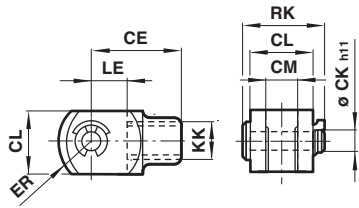

Style (F)	Ø	KK	CE	Ø CK _{h11}	CL	CM	ER	LE	RK	kg
QM/8025/25	32	M10x1,25	40	10	20	10	16	20	28	0,09
QM/8040/25	40	M12x1,25	48	12	24	12	19	24	32	0,13
QM/8050/25	50/63	M16x1,5	64	16	32	16	25	32	41,5	0,33
QM/8080/25	80/100	M20x1,5	80	20	40	20	32	40	50	0,67
QM/8125/25	125	M27x2	110	30	55	30	45	54	62	1,35

Front or rear detachable trunnion FH

Conforms to VDMA 24562 part 2, type MT 5/6

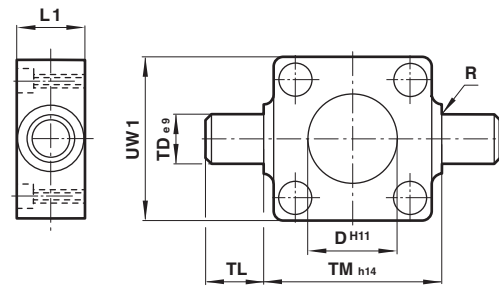

Style (FH)	Ø	Ø D _{h11}	L1	R	Ø TD _{e9}	TL	TM _{h14}	UW1	kg
QA/8032/34	32	30	16	1	12	12	50	50	0,20
QA/8040/34	40	35	20	1,6	16	16	63	55	0,38
QA/8050/34	50	40	24	1,6	16	16	75	65	0,60
QA/8063/34	63	45	24	1,6	20	20	90	75	1,10
QA/8080/34	80	45	28	1,6	20	20	110	100	1,90
QA/8100/34	100	55	38	2	25	25	132	120	3,50
QA/8125/34	125	60	50	2	25	25	160	145	6,50

Universal piston rod eye UF

Conforms to DIN ISO 8139

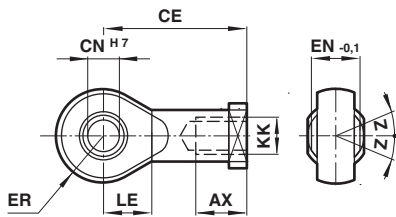

Style (UF)	Ø	Thread KK	AX	CE	Ø CN _{H7}	EN _{-0,1}	ER	LE	Z	kg
QM/8025/32	32	M10x1,25	20	43	10	14	14	15	13°	0,09
QM/8040/32	40	M12x1,25	22	50	12	16	16	17	13°	0,13
QM/8050/32	50/63	M16x1,5	28	64	16	21	21	22	15°	0,33
QM/8080/32	80/100	M20x1,5	33	77	20	25	25	26	15°	0,67
QM/8125/32	125	M27x2	51	110	30	37	35	36	15°	1,35

Rear eye R

Conforms to ISO 15552, type MP4

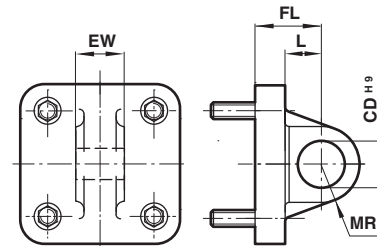

Style (R)	Ø	Ø CD _{H9}	EW	FL	L	MR	kg
QA/8032/27	32	10	25,8	22	13	9	0,09
QA/8040/27	40	12	27,8	25	16	12	0,11
QA/8050/27	50	12	31,7	27	17	12	0,17
QA/8063/27	63	16	39,7	32	22	15	0,24
QA/8080/27	80	16	49,7	36	22	15	0,37
QA/8100/27	100	20	59,7	41	27	20	0,59
QA/8125/27	125	25	69,7	50	33	25	3,20

Adjustable trunnion mounting UH

Conforms to ISO 15552, type MT4

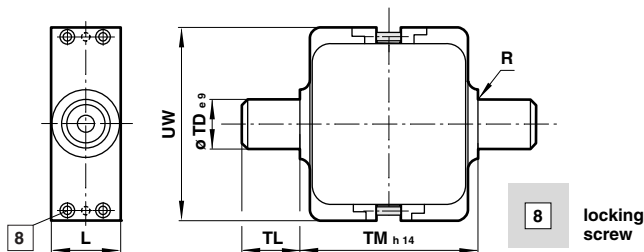

Style (UH)	Ø	L	R	Ø TD _{e9}	TL	TM _{h14}	UW	Torque max. (Nm)	kg
PQA/182032/40	32	25	1	12	12	50	58	2,0	0,16
PQA/182040/40	40	28	1,6	16	16	63	65	3,5	0,35
PQA/182050/40	50	28	1,6	16	16	75	80	3,5	0,65
PQA/182063/40	63	36	1,6	20	20	90	96	5,0	0,85
PQA/182080/40	80	36	1,6	20	20	110	116	6,0	1,20
PQA/182100/40	100	48	2	25	25	132	140	6,0	2,30
PQA/182125/40	125	48	2	25	25	160	163	6,0	3,30

Note: style 'UH': It is most important that the locking screws which secure the mounting to the cylinder barrel are tightened to the torque figures shown in the table below. For maximum energy input, consult our Technical Service.

Universal rear mounting UR

Conforms ISO 15552, type MP6

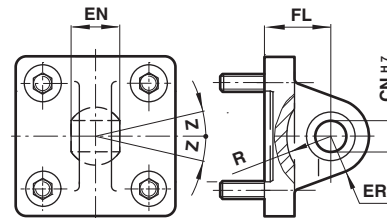

Style (UR)	Ø	Ø CN _{H7}	EN	ER	FL	R	Z	kg
QA/8032/33	32	10	14	16	22	14,5	13°	0,15
QA/8040/33	40	12	16	19	25	18	13°	0,25
QA/8050/33	50	16	21	21	27	19	13°	0,40
QA/8063/33	63	16	21	24	32	24	15°	0,55
QA/8080/33	80	20	25	28	36	24	15°	0,90
QA/8100/33	100	20	25	30	41	29	15°	1,50
QM/8125/33	125	30	37	40	50	36	15°	2,70

Swivel bearing S

Conforms ISO 15552, type AT4

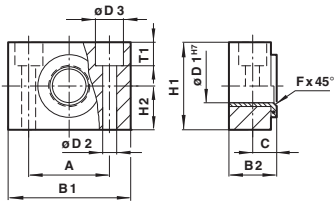

Type (S)	Ø	A	B1	B2	C	Ø D1 ^{H7}	Ø D2	Ø D3	Fx 45°	H1	H2	T1	kg
QA/8032/41	32	32	46	18	10,5	12	6,6	11	1	30	15	6,8	0,10
QA/8040/41	40/50	36	55	21	12	16	9	15	1,6	36	18	9	0,14
QA/8063/41	63/80	42	65	23	13	20	11	18	1,6	40	20	11	0,18
QA/8100/41	100/125	50	75	28,5	16	25	14	20	2	50	25	13	0,34

Wide hinge SW

Conforms to ISO 15552, type AB7

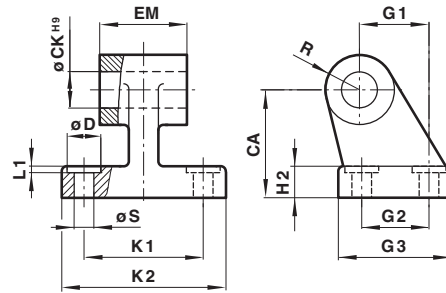

Typ (SW)	Ø	CA	Ø CK ^{H9}	Ø D	H2	EM	G1	G2	G3	K1	K2	L1	R	Ø S	kg
M/P19493	32	32	10	11	8	26,5	21	18	31	38	51	1,6	10	6,6	0,05
M/P19494	40	36	12	11	10	28,5	24	22	35	41	54	1,6	11	6,6	0,07
M/P19495	50	45	12	15	12	32,5	33	30	45	50	65	1,6	13	9	0,14
M/P19496	63	50	16	15	12	40,5	37	35	50	52	67	1,6	15	9	0,18
M/P19497	80	63	16	18	14	50,5	47	40	60	66	86	2,5	15	11	0,28
M/P19498	100	71	20	18	15	60,5	55	50	70	76	96	2,5	19	11	0,42
M/P19499	125	90	25	20	20	70,5	70	60	90	94	124	3,2	22	14	2,70

Swivel hinge US

Conforms to VDMA 24562 part 2

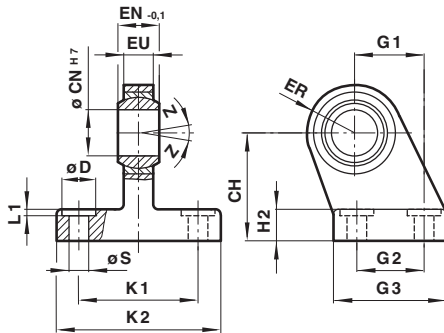

Typ (US)	Ø	CH	Ø CN ^{H17}	Ø EN-0,1	ER	EU	G1	G2	G3	H2	K1	K2	L1	Ø Z	kg	
M/P40310	32	32	10	11	14	16	10,5	21	18	31	8	38	51	1,6	6,6	13° 0,19
M/P40311	40	36	12	11	16	19	12	24	22	35	10	41	54	1,6	6,6	13° 0,24
M/P40312	50	45	16	15	21	21	15	33	30	45	12	50	65	1,6	9	13° 0,46
M/P40313	63	50	16	15	21	24	15	37	35	50	12	52	67	1,6	9	15° 0,59
M/P40314	80	63	20	18	25	28	18	47	40	60	14	66	86	2,5	11	15° 1,03
M/P40315	100	71	20	18	25	30	18	55	50	70	15	76	96	2,5	11	15° 1,40
M/P71355	125	90	30	20	37	40	25	70	60	90	20	94	124	3,2	14	15° 3,10

Narrow hinge SS

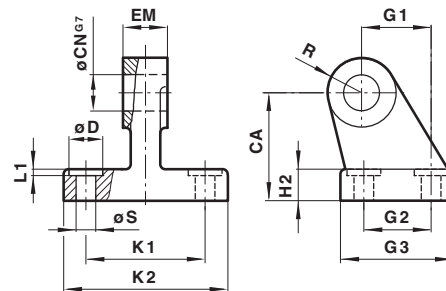

Typ (SS)	Ø	CA	Ø CN ^{G7}	Ø D	H2	EM	G1	G2	G3	K1	K2	L1	R	Ø S	kg
M/P19931	32	32	10	11	8	10	21	18	31	38	51	1,6	10	6,6	0,15
M/P19932	40	36	12	11	10	12	24	22	35	41	54	1,6	11	6,6	0,20
M/P19933	50	45	10	15	12	16	33	30	45	50	65	1,6	13	9	0,48
M/P19934	63	50	16	15	12	16	37	35	50	52	67	1,6	15	9	0,50
M/P19935	80	63	20	18	14	20	47	40	60	66	86	2,5	15	11	0,75
M/P19936	100	71	20	18	15	20	55	50	70	76	96	2,5	19	11	1,20
M/P19937	125	90	25	20	20	30	70	60	90	94	124	3,2	22	14	2,50

Valve mounting kit

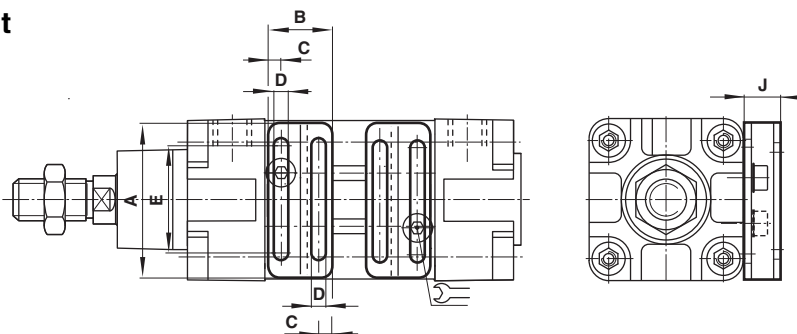

Type	Ø	A	B	C	D	E	F	G	H	J	kg	
QA/180050/22/54	50/63	60	37	7	4,5	46	8,5	5,5	2	12	3	0,02
QA/180080/22/54	80/100/125	90	37	7	4,5	76	8,5	6,5	2	12	3	0,02

Groove cover M/K72725/1000

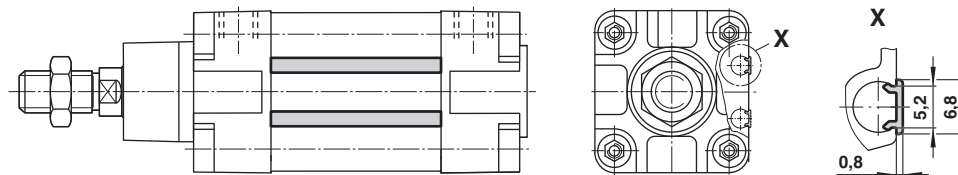

Groove key M/P72816

Weight: 0,010 kg

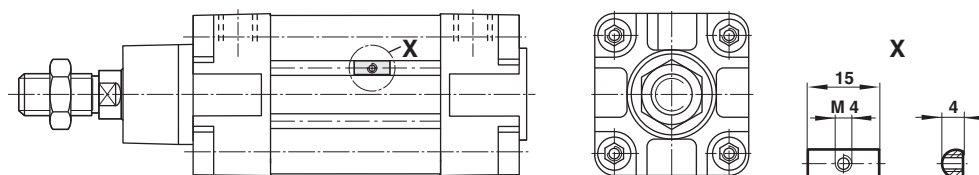

Spares

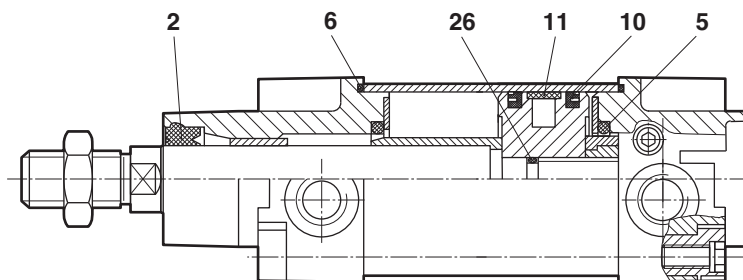

Cylinder Ø	Type	Spares kit	Comprising Item	Description	Quantity
32	PRA/182032	QA/8032/00	2	Piston rod seal	1
32	PRA/182032/M	QA/8032/00	5	Cushion seal	2
40	PRA/182040, PRA/182040/M	QA/8040/00	6	O-ring	2
50	PRA/182050, PRA/182050/M	QA/8050/00	10	Piston seal	2
63	PRA/182063, PRA/182063/M	QA/8063/00	11	Wear ring	1
80	PRA/182080, PRA/182080/M	QA/8080/00	26	O-ring	1
100	PRA/182100, PRA/182100/M	QA/8100/00		(Ø 32 to 100 mm)	
125	PRA/182125, PRA/182125/M	QA/8125/00			

* Insert stroke length

Note: please quote the cylinder type number when ordering spares kits and piston rods!